

● **Outer dimensions (mm)**

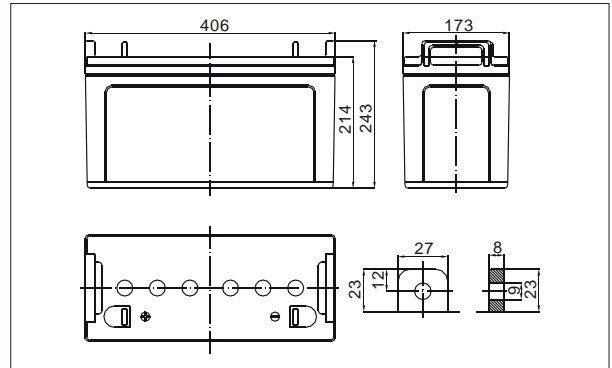

TianChang sealed lead-acid rechargeable battery (VRLA battery) is leak-proof and maintenance free. The Superiority of VRLA battery is derived from its uniquely efficient oxygen recombination technology. The oxygen evolved from the positive plates diffuses through the micro porous glass fiber mat to the negative plates where it is changed back to water by recombination reaction, eliminating the need for water addition. The result is a maintenance free battery.

● **Battery Construction**

Component	Positive plate	Negative plate	Container	Cover	Safety valve	Terminal	Separator	Electrolyte
Raw material	Lead dioxide	Lead	ABS	ABS	Rubber	Pb	Fiberglass	Sulfuric acid

● **General Features**

- Absorbent Glass Mat (AGM) technology for efficient gas recombination of up to 99% and freedom from electrolyte maintenance or water adding.
- Not restricted for air transport-complies with IATA/ICAO Special Provision A67.
- UL-recognized component.
- Can be mounted in any orientation.
- Computer designed lead, calcium tin alloy grid for high power density.
- Long service life, float or cyclic applications.
- Maintenance-free operation.
- Low self discharge.

● **Application**

- Alarm System
- Medical Equipment
- Cable Television
- Control Equipment
- UPS
- Communication Equipment
- Toys
- Emergency power System
- Power Tools
- Security System

● **Specifications**

Nominal Voltage		12V
Capacity (10 hr 25°C)		120Ah
Design Life		10 Years
Dimensions	Length	409 mm (16.1 inch)
	Width	176 mm (6.93inch)
	Height	225 mm (8.86 inch)
	Total Height	225 mm (8.86 inch)
Approx. Weight		33.5 Kg
Capacity 25°C (77°F)	10 hr rate	120Ah
	3 hr rate	96Ah
	1 hr rate	78Ah
Internal Resistance (Full charged Battery at 25°C (77°F))		4m Ω

Capacity affected by Temperature (20hr)	40°C	102%
	25°C	100%
	0°C	85%
	-15°C	65%
Self-Discharge at 25°C	3 month	Remaining capacity: 91%
	6 month	Remaining capacity: 82%
	12 month	Remaining capacity: 65%
Normal operating temperature		25°C ± 3°C (77°F ± 5°F)
Operating temperature range		-15°C ~ 50°C (5 ~ 122°F)
Float charging voltage (25°C)		13.60 to 13.80V
Cyclic charging voltage (25°C)		14.50 to 14.90V
Maximum charging current		32A
Terminal material		Copper
Maximum Discharge current		800A (5sec)

Charge characteristic Curve for standby use

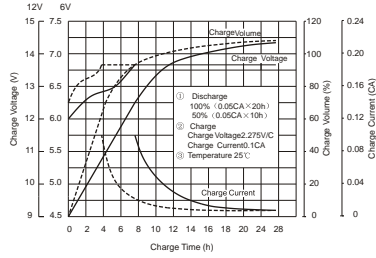

Discharge characteristic (25°C/77°F)

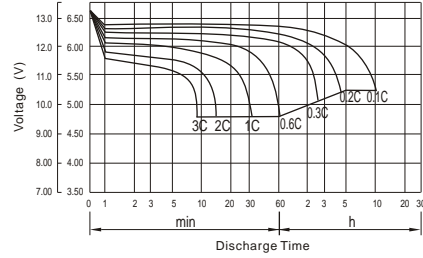

Relationship between charging voltage and temperature

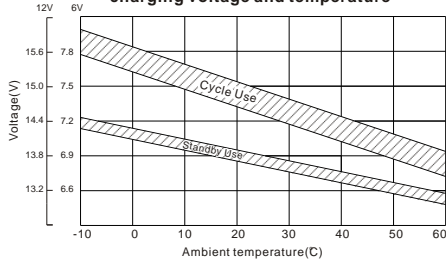

Self-discharge characteristic

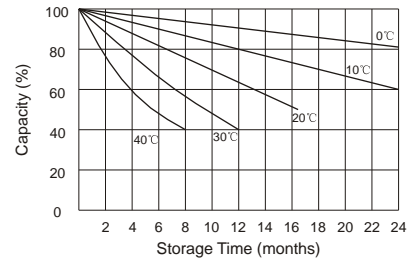

Temperature effects on float life

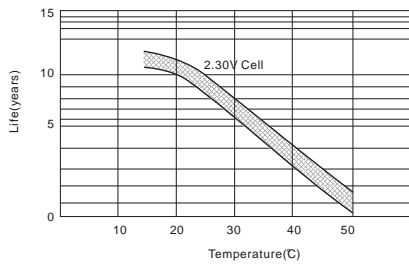

Temperature effects on capacity

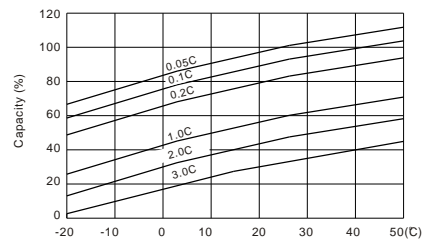

Life characteristics of Standby use

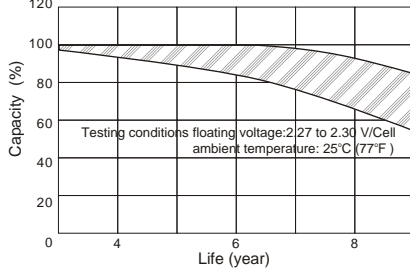

Cycle service life in relation to depth of discharge

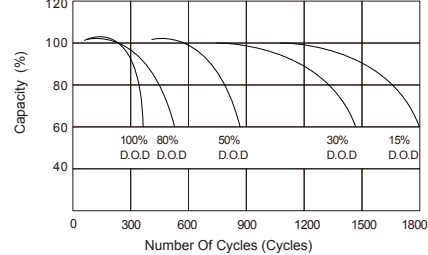

Discharge Constant Current (Amperes at 77°F25°C)

F.V/Time	5MIN	10MIN	15MIN	30MIN	1HR	2HR	3HR	4HR	5HR	8HR	10HR	20HR
9.60V	365.5	266.8	217.7	135.2	78.00	46.67	32.26	26.44	21.64	14.91	12.60	6.93
10.0V	355.0	253.8	213.2	133.0	77.64	46.32	32.14	26.32	21.51	14.78	12.48	6.81
10.2V	344.5	244.9	209.9	131.8	76.92	45.97	31.89	26.19	21.39	14.66	12.36	6.68
10.5V	309.3	226.0	199.8	128.5	76.20	45.62	31.77	25.95	21.13	14.54	12.24	6.55
10.8V	279.2	206.1	184.2	122.9	74.40	44.80	30.90	25.34	20.75	14.30	12.12	6.43
11.1V	238.4	184.2	165.2	115.1	70.68	42.81	29.54	24.11	19.86	13.69	11.76	6.05

Discharge Constant Power (Watts at 77°F25°C)

F.V/Time	5MIN	10MIN	15MIN	30MIN	1HR	2HR	3HR	4HR	5HR	8HR	10HR	20HR
9.60V	3781	2841	2395	1541	901.3	550.1	383.9	315.1	258.2	178.0	150.6	83.11
10.0V	3706	2754	2356	1522	899.2	547.2	384.0	314.7	257.5	177.1	149.7	81.67
10.2V	3664	2681	2330	1512	892.2	543.9	382.3	314.1	256.6	176.0	148.3	80.16
10.5V	3336	2497	2222	1476	884.2	540.0	380.9	311.1	253.6	174.5	146.9	78.65
10.8V	3038	2302	2054	1415	867.9	533.1	370.5	304.0	249.0	171.6	145.4	77.13
11.1V	2669	2081	1849	1329	830.7	513.3	354.5	289.4	238.3	164.3	141.1	72.60

(Note) The above characteristics data are average values.