

● **Outer dimensions (mm)**

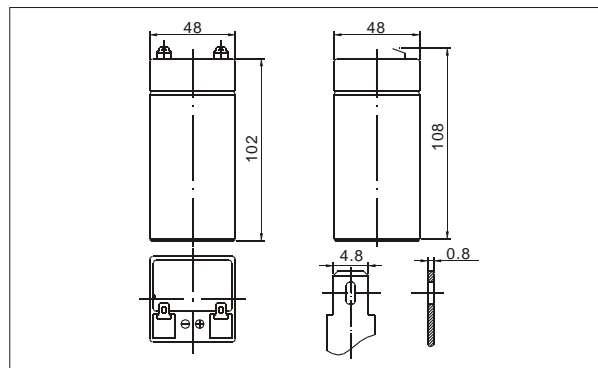

TianChang sealed lead-acid rechargeable battery (VRLA battery) is leak-proof and maintenance free. The Superiority of VRLA battery is derived from its uniquely efficient oxygen recombination technology. The oxygen evolved from the positive plates diffuses through the micro porous glass fiber mat to the negative plates where it is changed back to water by recombination reaction, eliminating the need for water addition. The result is a maintenance free battery.

● **Battery Construction**

Component	Positive plate	Negative plate	Container	Cover	Safety valve	Terminal	Separator	Electrolyte
Raw material	Lead dioxide	Lead	ABS	ABS	Rubber	Copper	Fiberglass	Sulfuric acid

● **General Features**

- Absorbent Glass Mat (AGM) technology for efficient gas recombination of up to 99% and freedom from electrolyte maintenance or water adding.
- Not restricted for air transport-complies with IATA/ICAO Special Provision A67.
- UL-recognized component.
- Can be mounted in any orientation.
- Computer designed lead, calcium tin alloy grid for high power density.
- Long service life, float or cyclic applications.
- Maintenance-free operation.
- Low self discharge.

● **Application**

- Alarm System
- Medical Equipment
- Cable Television
- Control Equipment
- UPS
- Communication Equipment
- Toys
- Emergency power System
- Power Tools
- Security System

● **Specifications**

Nominal Voltage		4V
Capacity (20 hr 25°C)		3.2 Ah
Design Life		5 Years
Dimensions	Length	90mm (3.53 inch)
	Width	34mm (1.34 inch)
	Height	59 mm (2.32 inch)
	Total Height	64mm (2.52 inch)
Approx. Weight		0.40 Kg (0.97 lbs)
Capacity 25°C (77°F)	20 hr rate	3.20Ah
	10 hr rate	2.98Ah
	5 hr rate	2.72Ah
	1 hr rate	1.92Ah
Internal Resistance (Full charged Battery at 25°C (77°F))		22m Ω

Capacity affected by Temperature (20hr)	40°C	102%
	25°C	100%
	0°C	85%
	-15°C	65%
Self-Discharge at 25°C	3 month	Remaining capacity: 91%
	6 month	Remaining capacity: 82%
	12 month	Remaining capacity: 65%
Normal operating temperature		25°C ± 3°C (77°F ± 5°F)
Operating temperature range		-15°C ~ 50°C (5 ~ 122°F)
Float charging voltage (25°C)		4.46 to 4.60V
Cyclic charging voltage (25°C)		4.80 to 5.00V
Maximum charging current		1.28A
Terminal material		Copper
Maximum Discharge current		48A (5sec)

Charge characteristic Curve for standby use

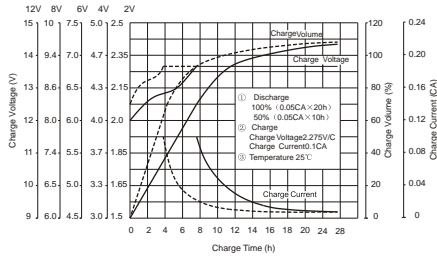

Discharge characteristic Curve

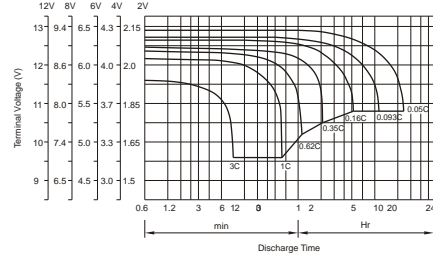

Relationship between charging voltage and temperature

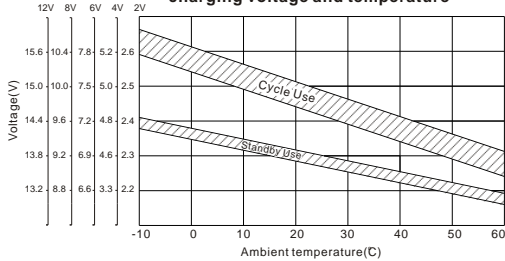

Self-discharge characteristic

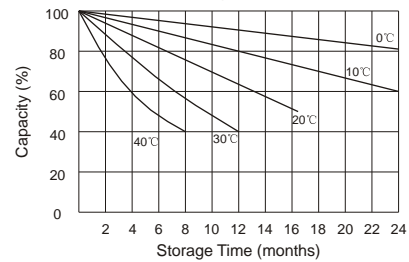

Temperature effects on float life

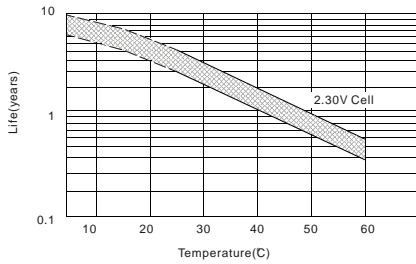

Temperature effects on capacity

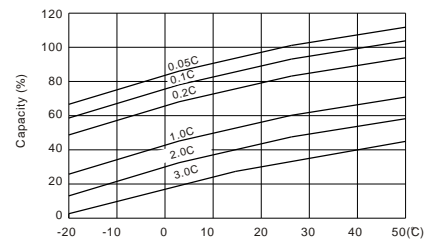

Life characteristics of Standby use

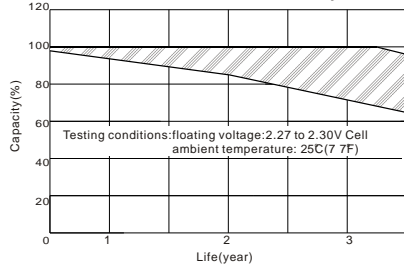

Cycle service life in relation to depth of discharge

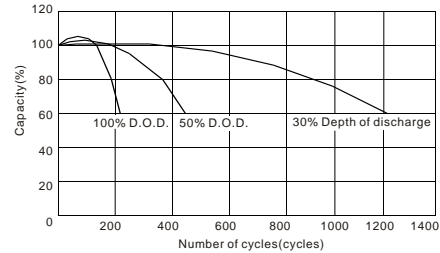

Constant Current Discharge Characteristics(Amperes,25°C)

Constant Power Discharge Characteristics(Watts,25°C)

F.V/Time	Constant Current Discharge Characteristics(Amperes,25°C)								Constant Power Discharge Characteristics(Watts,25°C)							
	5min	10min	30min	1h	3h	5h	10h	20h	5min	10min	30min	1h	3h	5h	10h	20h
3.60V	8.03	7.63	3.52	2.00	0.85	0.56	0.32	0.16	33.83	22.40	9.51	5.76	3.04	2.01	1.13	0.65
3.50V	8.96	8.00	3.60	2.05	0.85	0.56	0.32	0.16	36.48	24.09	10.15	6.08	3.13	2.08	1.16	0.65
3.40V	10.24	8.11	3.71	2.11	0.88	0.59	0.32	0.16	39.27	25.78	10.81	6.40	3.20	2.17	1.17	0.66
3.20V	11.23	8.53	3.87	2.19	0.88	0.59	0.32	0.16	44.80	29.19	12.00	7.04	3.36	2.24	1.17	0.67

