

● **Outer dimensions (mm)**

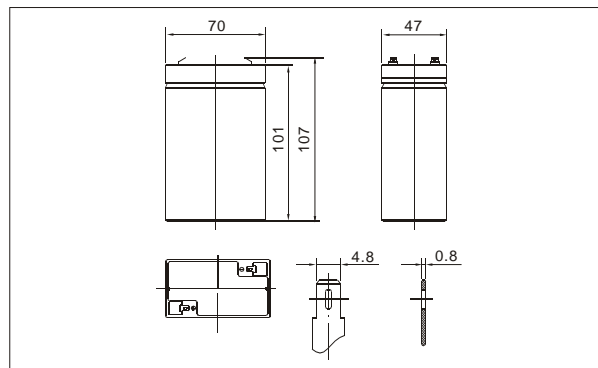

TianChang sealed lead-acid rechargeable battery (VRLA battery) is leak-proof and maintenance free. The Superiority of VRLA battery is derived from its uniquely efficient oxygen recombination technology. The oxygen evolved from the positive plates diffuses through the micro porous glassfiber mat to the negative plates where it is changed back to water by recombination reaction, eliminating the need for water addition .The result is a maintenance free battery.

● **Battery Construction**

Component	Positive plate	Negative plate	Container	Cover	Safety valve	Terminal	Separator	Electrolyte
Raw material	Lead dioxide	Lead	ABS	ABS	Rubber	Copper	Fiberglass	Sulfuric acid

● **General Features**

- Absorbent Glass Mat (AGM) technology for efficient gas recombination of up to 99% and freedom from electrolyte maintenance or water adding.
- Not restricted for air transport-complies with IATA/ICAO Special Provision A67.
- UL-recognized component.
- Can be mounted in any orientation.
- Computer designed lead, calcium tin alloy grid for high power density.
- Long service life, float or cyclic applications.
- Maintenance-free operation.
- Low self discharge.

● **Application**

- Alarm System
- Medical Equipment
- Cable Television
- Control Equipment
- UPS
- Communication Equipment
- Toys
- Emergency power System
- Power Tools
- Security System

● **Specifications**

Nominal Voltage		6V
Capacity (20 hr 25°C)		4 Ah
Design Life		5 Years
Dimensions	Length	70mm (2.76inch)
	Width	47mm (1.85 inch)
	Height	101 mm (3.98inch)
	Total Height	107mm (4.21inch)
Approx.Weight		0.66 Kg
Capacity 25°C (77°F)	20 hr rate	4Ah
	10 hr rate	3.72Ah
	5 hr rate	3.4Ah
	1 hr rate	2.4Ah
Internal Resistance (Full charged Battery at 25°C (77°F))		25m Ω

Capacity affected by Temperature (20hr)	40°C	102%
	25°C	100%
	0°C	85%
	-15°C	65%
Self-Discharge at 25°C	3 month	Remaining capacity: 91%
	6 month	Remaining capacity: 82%
	12 month	Remaining capacity: 65%
Normal operating temperature		25°C ±3°C (77°F ±5°F)
Operating temperature range		-15°C~50°C (5~122°F)
Float charging voltage (25°C)		6.80 to 6.90V
Cyclic charging voltage (25°C)		7.25 to 7.45V
Maximum charging current		1.60A
Terminal material		Copper
Maximum Discharge current		60A (5sec)

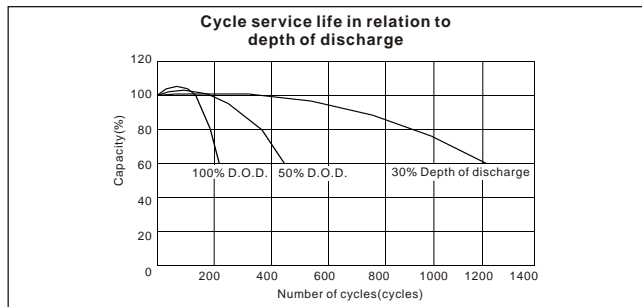
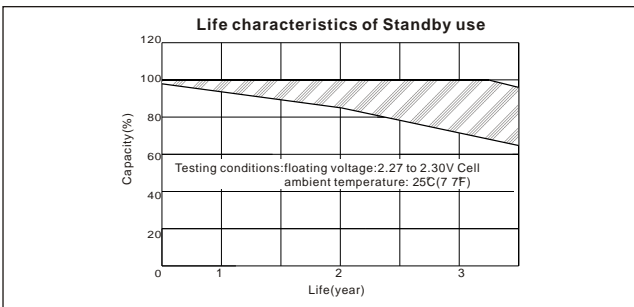
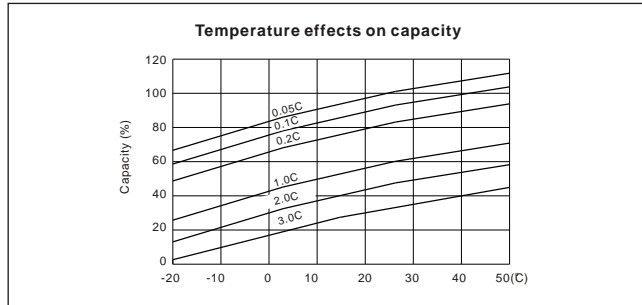
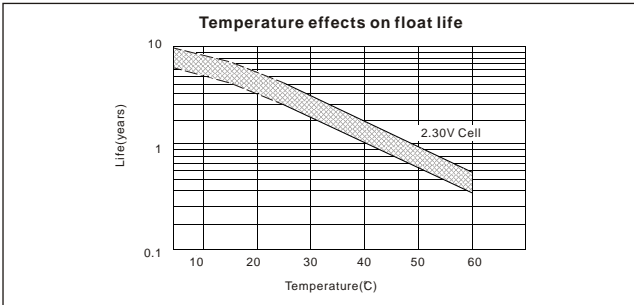
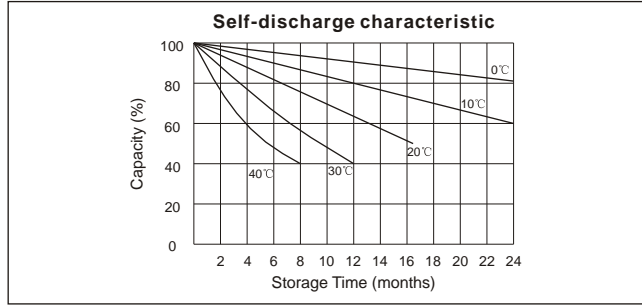
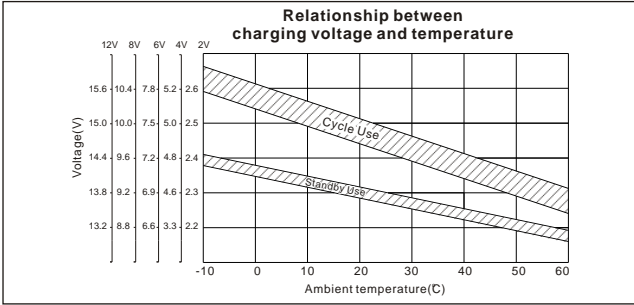
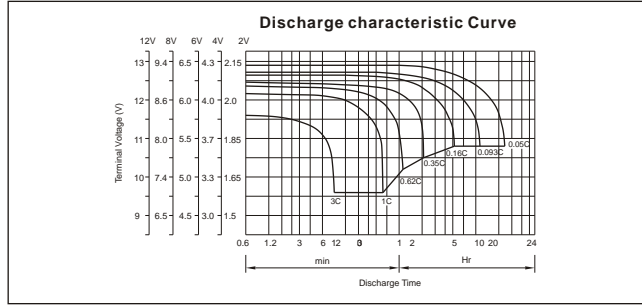
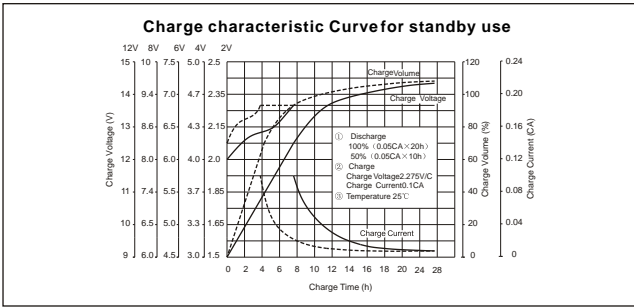

Constant current discharge ratings-amperes at 25

End Point Volts/Cell	5min	10min	15min	30min	1h	3h	5h	10h	20h
1.60V	14.2	9.96	7.58	4.27	2.63	1.10	0.72	0.410	0.210
1.65V	13.5	9.51	7.21	4.10	2.58	1.07	0.70	0.403	0.205
1.70V	12.7	8.98	6.84	3.92	2.52	1.03	0.68	0.395	0.203
1.75V	11.9	8.44	6.47	3.72	2.41	0.99	0.66	0.390	0.200
1.80V	11.1	8.00	6.10	3.54	2.29	0.94	0.64	0.382	0.196

Constant power discharge ratings-watts at 25

End Point Volts/Cell	5min	10min	15min	30min	1h	3h	5h	10h	20h
1.60V	26.3	18.4	14.1	7.98	4.94	2.08	1.37	0.78	0.40
1.65V	24.9	17.5	13.3	7.62	4.82	2.01	1.32	0.77	0.39
1.70V	23.3	16.4	12.6	7.25	4.68	1.93	1.28	0.75	0.39
1.75V	21.7	15.4	11.8	6.85	4.46	1.84	1.23	0.73	0.38
1.80V	20.0	14.4	11.0	6.44	4.20	1.73	1.18	0.71	0.37