

TC12-200-E

● **Outer dimensions (mm)**

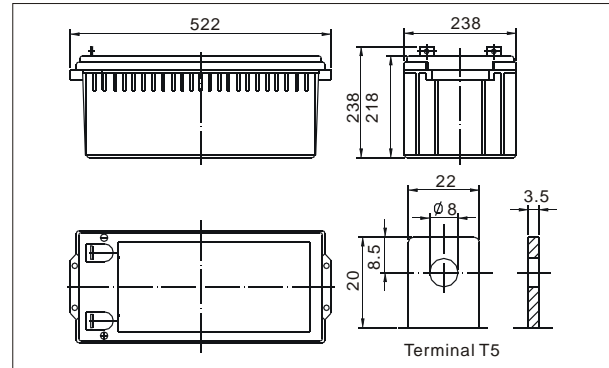

TianChang sealed lead-acid rechargeable battery (VRLA battery) is leak-proof and maintenance free. The Superiority of VRLA battery is derived from its uniquely efficient oxygen recombination technology. The oxygen evolved from the positive plates diffuses through the micro porous glass fiber mat to the negative plates where it is changed back to water by recombination reaction, eliminating the need for water addition. The result is a maintenance free battery.

● **Battery Construction**

Component	Positive plate	Negative plate	Container	Cover	Safety valve	Terminal	Separator	Electrolyte
Raw material	Lead dioxide	Lead	ABS	ABS	Rubber	Copper	Fiberglass	Sulfuric acid

● **General Features**

- Absorbent Glass Mat (AGM) technology for efficient gas recombination of up to 99% and freedom from electrolyte maintenance or water adding.
- Not restricted for air transport-complies with IATA/ICAO Special Provision A67.
- UL-recognized component.
- Can be mounted in any orientation.
- Computer designed lead, calcium tin alloy grid for high power density.
- Long service life, float or cyclic applications.
- Maintenance-free operation.
- Low self discharge.

● **Application**

- Alarm System
- Medical Equipment
- Cable Television
- Control Equipment
- UPS
- Communication Equipment
- Toys
- Emergency power System
- Power Tools
- Security System

● **Specifications**

Nominal Voltage		12V
Capacity (10 hr 25°C)		200Ah
Design Life		10 Years
Dimensions	Length	522 mm (20.55 inch)
	Width	238 mm (9.37 inch)
	Height	218 mm (8.58 inch)
	Total Height	238 mm (9.37 inch)
Approx. Weight		59 Kg
Capacity 25°C (77°F)	10 hr rate	200Ah
	3 hr rate	160Ah
	1 hr rate	130Ah
Internal Resistance (Full charged Battery at 25°C (77°F))		3mΩ

Capacity affected by Temperature (20hr)	40°C	102%
	25°C	100%
	0°C	85%
	-15°C	65%
Self-Discharge at 25°C	3 month	Remaining capacity: 91%
	6 month	Remaining capacity: 82%
	12 month	Remaining capacity: 65%
Normal operating temperature		25°C ± 3°C (77°F ± 5°F)
Operating temperature range		-15°C ~ 50°C (5 ~ 122°F)
Float charging voltage (25°C)		13.60 to 13.80V
Cyclic charging voltage (25°C)		14.50 to 14.90V
Maximum charging current		60A
Terminal material		Copper
Maximum Discharge current		1600A (5sec)

Charge characteristic Curve for standby use

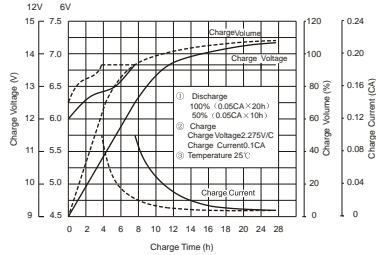

Discharge characteristic (25°C/77°F)

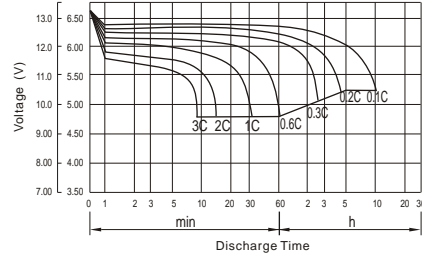

Relationship between charging voltage and temperature

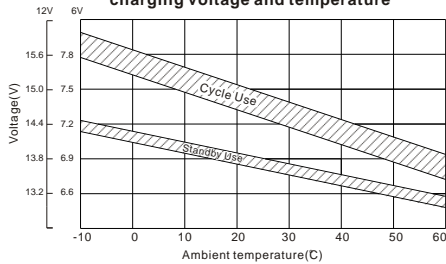

Self-discharge characteristic

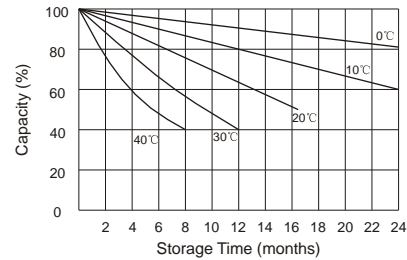

Temperature effects on float life

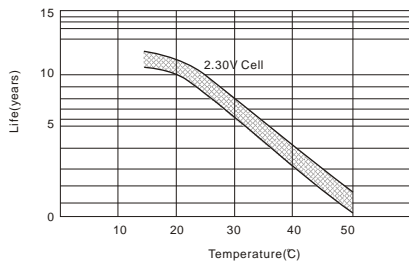

Temperature effects on capacity

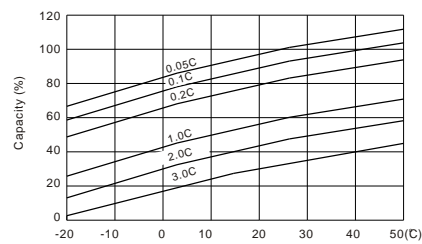

Life characteristics of Standby use

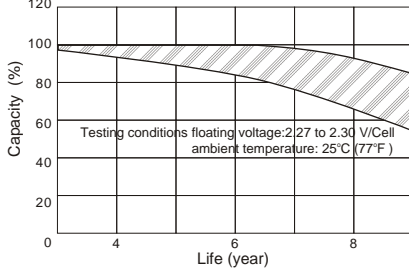

Cycle service life in relation to depth of discharge

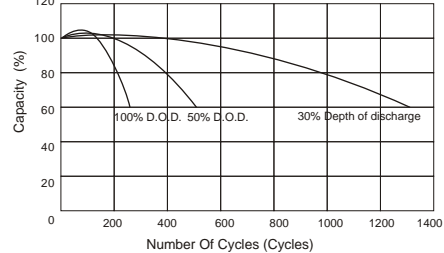

Discharge Constant Current (Amperes at 77°F/25°C)

F.V/Time	5MIN	10MIN	15MIN	30MIN	1HR	2HR	3HR	4HR	5HR	8HR	10HR	20HR
9.60V	545.12	408.33	344.69	225.33	130.00	77.788	53.766	44.064	36.067	24.844	21.006	11.553
10.0V	529.36	388.53	337.62	221.61	129.40	77.204	53.560	43.860	35.855	24.642	20.804	11.343
10.2V	513.67	374.81	332.31	219.65	128.20	76.619	53.148	43.656	35.643	24.440	20.602	11.133
10.5V	461.25	345.86	316.41	214.16	127.00	76.034	52.942	43.248	35.219	24.238	20.400	10.923
10.8V	416.33	315.39	291.66	204.76	124.00	74.669	51.500	42.228	34.582	23.834	20.198	10.713
11.1V	355.48	281.87	261.61	191.83	117.80	71.355	49.234	40.188	33.097	22.824	19.592	10.083

Discharge Constant Power (Watts at 77°F/25°C)

F.V/Time	5MIN	10MIN	15MIN	30MIN	1HR	2HR	3HR	4HR	5HR	8HR	10HR	20HR
9.6V	5638.2	4348.7	3791.6	2568.8	1502.2	916.87	639.82	525.24	430.28	296.63	251.02	138.52
10.0V	5527.2	4215.5	3730.7	2537.4	1498.6	912.01	640.04	524.57	429.18	295.21	249.44	136.12
10.2V	5464.0	4104.2	3688.7	2519.4	1487.0	906.51	637.24	523.44	427.71	293.28	247.22	133.60
10.5V	4974.3	3821.8	3518.4	2460.7	1473.7	899.92	634.77	518.54	422.62	290.85	244.80	131.08
10.8V	4530.6	3522.9	3252.0	2358.8	1446.5	888.45	617.49	506.74	414.98	286.00	242.38	128.56
11.1V	3979.4	3185.1	2927.4	2215.6	1384.6	855.45	590.81	482.26	397.16	273.89	235.10	120.99

(Note) The above characteristics data are average values.