

● Outer dimensions (mm)

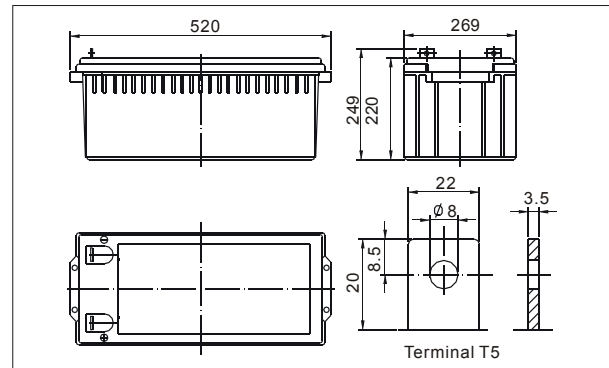

TianChang sealed lead-acid rechargeable battery (VRLA battery) is leak-proof and maintenance free. The Superiority of VRLA battery is derived from its uniquely efficient oxygen recombination technology. The oxygen evolved from the positive plates diffuses through the micro porous glass fiber mat to the negative plates where it is changed back to water by recombination reaction, eliminating the need for water addition. The result is a maintenance free battery.

● Battery Construction

| Component | Positive plate | Negative plate | Container | Cover | Safety valve | Terminal | Separator | Electrolyte |
|--------------|----------------|----------------|-----------|-------|--------------|----------|------------|---------------|
| Raw material | Lead dioxide | Lead | ABS | ABS | Rubber | Copper | Fiberglass | Sulfuric acid |

● General Features

- Absorbent Glass Mat (AGM) technology for efficient gas recombination of up to 99% and freedom from electrolyte maintenance or water adding.
- Not restricted for air transport-complies with IATA/ICAO Special Provision A67.
- UL-recognized component.
- Can be mounted in any orientation.
- Computer designed lead, calcium tin alloy grid for high power density.
- Long service life, float or cyclic applications.
- Maintenance-free operation.
- Low self discharge.

● Application

- Alarm System
- Medical Equipment
- Cable Television
- Control Equipment
- UPS
- Communication Equipment
- Toys
- Emergency power System
- Power Tools
- Security System

● Specifications

| | | |
|---|--------------|---------------------|
| Nominal Voltage | | 12V |
| Capacity (10 hr 25°C) | | 260 Ah |
| Design Life | | 10 Years |
| Dimensions | Length | 520 mm (20.47inch) |
| | Width | 269 mm (10.59 inch) |
| | Height | 220 mm (8.66 inch) |
| | Total Height | 249 mm (9.80 inch) |
| Approx. Weight | | 72 Kg |
| Capacity 25°C (77°F) | 10 hr rate | 260A h |
| | 3 hr rate | 210A h |
| | 1 hr rate | 173.5 Ah |
| Internal Resistance (Full charged Battery at 25°C (77°F)) | | 2.6m Ω |

| | | |
|---|----------|--------------------------|
| Capacity affected by Temperature (20hr) | 40°C | 102% |
| | 25°C | 100% |
| | 0°C | 85% |
| | -15°C | 65% |
| Self-Discharge at 25°C | 3 month | Remaining capacity: 91% |
| | 6 month | Remaining capacity: 82% |
| | 12 month | Remaining capacity: 65% |
| Normal operating temperature | | 25°C ± 3°C (77°F ± 5°F) |
| Operating temperature range | | -15°C ~ 50°C (5 ~ 122°F) |
| Float charging voltage (25°C) | | 13.60 to 13.80V |
| Cyclic charging voltage (25°C) | | 14.50 to 14.90V |
| Maximum charging current | | 75A |
| Terminal material | | Copper |
| Maximum Discharge current | | 2000A (5sec) |

Charge characteristic Curve for standby use

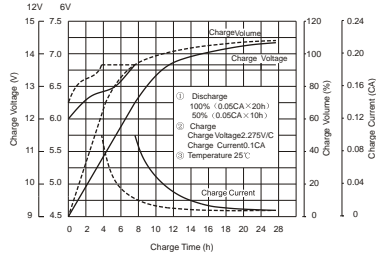

Discharge characteristic (25°C/77°F)

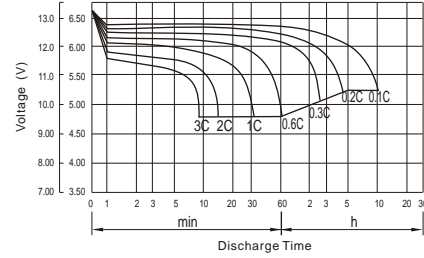

Relationship between charging voltage and temperature

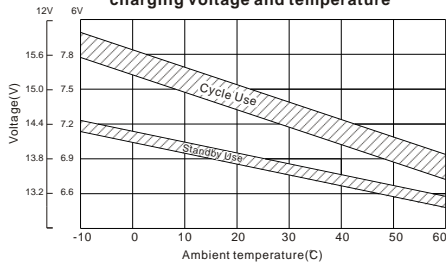

Self-discharge characteristic

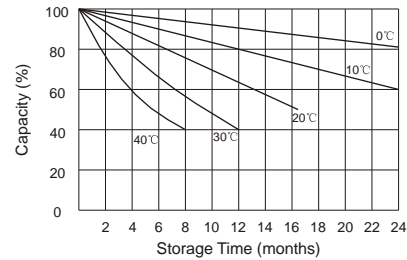

Temperature effects on float life

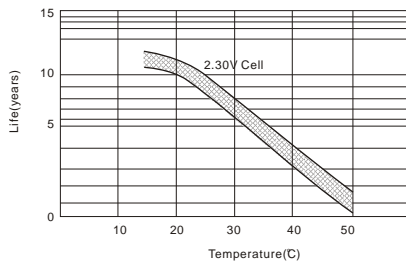

Temperature effects on capacity

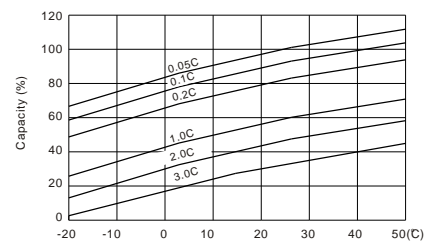

Life characteristics of Standby use

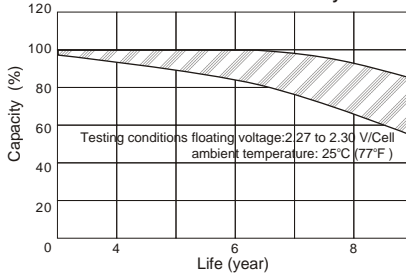

Cycle service life in relation to depth of discharge

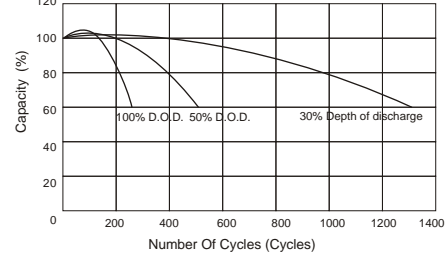

Discharge Constant Current (Amperes at 77°F/25°C)

| F.V/Time | 5MIN | 10MIN | 15MIN | 30MIN | 1HR | 2HR | 3HR | 4HR | 5HR | 8HR | 10HR | 20HR |
|----------|-------|-------|-------|-------|-------|-------|-------|-------|-------|-------|-------|-------|
| 9.60V | 708.7 | 530.8 | 448.1 | 292.9 | 169.0 | 101.1 | 69.90 | 57.28 | 46.89 | 32.30 | 27.31 | 15.02 |
| 10.0V | 688.2 | 505.1 | 438.9 | 288.1 | 168.2 | 100.4 | 69.63 | 57.02 | 46.61 | 32.03 | 27.05 | 14.75 |
| 10.2V | 667.8 | 487.3 | 432.0 | 285.5 | 166.7 | 99.60 | 69.09 | 56.75 | 46.34 | 31.77 | 26.78 | 14.47 |
| 10.5V | 599.6 | 449.6 | 411.3 | 278.4 | 165.1 | 98.84 | 68.82 | 56.22 | 45.78 | 31.51 | 26.52 | 14.20 |
| 10.8V | 541.2 | 410.0 | 379.2 | 266.2 | 161.2 | 97.07 | 66.95 | 54.90 | 44.96 | 30.98 | 26.26 | 13.93 |
| 11.1V | 462.1 | 366.4 | 340.1 | 249.4 | 153.1 | 92.76 | 64.00 | 52.24 | 43.03 | 29.67 | 25.47 | 13.11 |

Discharge Constant Power (Watts at 77°F/25°C)

| F.V/Time | 5MIN | 10MIN | 15MIN | 30MIN | 1HR | 2HR | 3HR | 4HR | 5HR | 8HR | 10HR | 20HR |
|----------|------|-------|-------|-------|------|------|-------|-------|-------|-------|-------|-------|
| 9.60V | 7330 | 5653 | 4929 | 3339 | 1953 | 1192 | 831.8 | 682.8 | 559.4 | 385.6 | 326.3 | 180.1 |
| 10.0V | 7185 | 5480 | 4850 | 3299 | 1948 | 1186 | 832.1 | 681.9 | 557.9 | 383.8 | 324.3 | 177.0 |
| 10.2V | 7103 | 5335 | 4795 | 3275 | 1933 | 1178 | 828.4 | 680.5 | 556.0 | 381.3 | 321.4 | 173.7 |
| 10.5V | 6467 | 4968 | 4574 | 3199 | 1916 | 1170 | 825.2 | 674.1 | 549.4 | 378.1 | 318.2 | 170.4 |
| 10.8V | 5890 | 4580 | 4228 | 3066 | 1880 | 1155 | 802.7 | 658.8 | 539.5 | 371.8 | 315.1 | 167.1 |
| 11.1V | 5173 | 4141 | 3806 | 2880 | 1800 | 1112 | 768.1 | 626.9 | 516.3 | 356.1 | 305.6 | 157.3 |

(Note) The above characteristics data are average values.