

● **Outer dimensions (mm)**

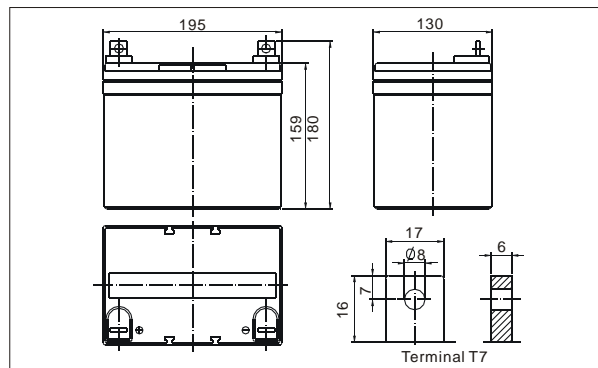

TianChang sealed lead-acid rechargeable battery (VRLA battery) is leak-proof and maintenance free. The Superiority of VRLA battery is derived from its uniquely efficient oxygen recombination technology. The oxygen evolved from the positive plates diffuses through the micro porous glass fiber mat to the negative plates where it is changed back to water by recombination reaction, eliminating the need for water addition. The result is a maintenance free battery.

● **Battery Construction**

Component	Positive plate	Negative plate	Container	Cover	Safety valve	Terminal	Separator	Electrolyte
Raw material	Lead dioxide	Lead	ABS	ABS	Rubber	Pb	Fiberglass	Sulfuric acid

● **General Features**

- Absorbent Glass Mat (AGM) technology for efficient gas recombination of up to 99% and freedom from electrolyte maintenance or water adding.
- Not restricted for air transport-complies with IATA/ICAO Special Provision A67.
- UL-recognized component.
- Can be mounted in any orientation.
- Computer designed lead, calcium tin alloy grid for high power density.
- Long service life, float or cyclic applications.
- Maintenance-free operation.
- Low self discharge.

● **Application**

- Alarm System
- Medical Equipment
- Cable Television
- Control Equipment
- UPS
- Communication Equipment
- Toys
- Emergency power System
- Power Tools
- Security System

● **Specifications**

Nominal Voltage		12V
Capacity (10 hr 25°C)		33Ah
Design Life		10 Years
Dimensions	Length	195 mm (7.68 inch)
	Width	130 mm (5.12 inch)
	Height	159 mm (6.26 inch)
	Total Height	180 mm (7.09 inch)
Approx. Weight		10.2 Kg (22.5 lbs)
Capacity 25°C (77°F)	10 hr rate	33Ah
	3 hr rate	26.4Ah
	1 hr rate	21.45Ah
Internal Resistance (Full charged Battery at 25°C (77°F))		10m Ω

Capacity affected by Temperature (20hr)	40°C	102%
	25°C	100%
	0°C	85%
	-15°C	65%
Self-Discharge at 25°C	3 month	Remaining capacity: 91%
	6 month	Remaining capacity: 82%
	12 month	Remaining capacity: 65%
Normal operating temperature		25°C ± 3°C (77°F ± 5°F)
Operating temperature range		-15°C ~ 50°C (5 ~ 122°F)
Float charging voltage (25°C)		13.6 to 13.8V
Cyclic charging voltage (25°C)		14.5 to 14.9V
Maximum charging current		9.9A
Terminal material		Pb
Maximum Discharge current		396A (5sec)

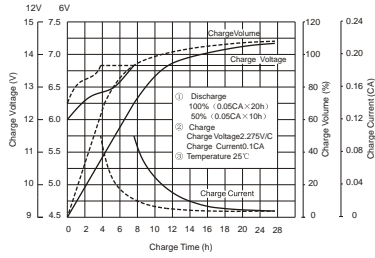
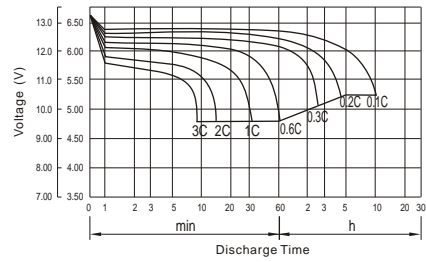
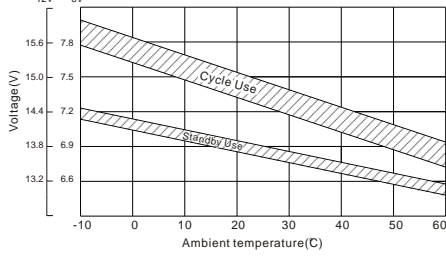
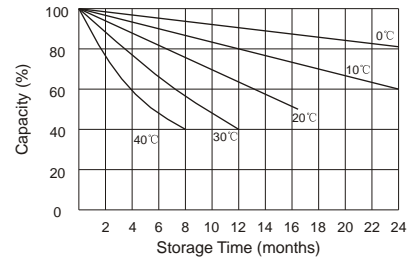
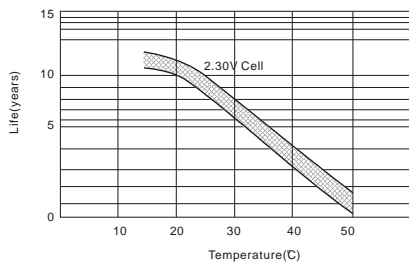
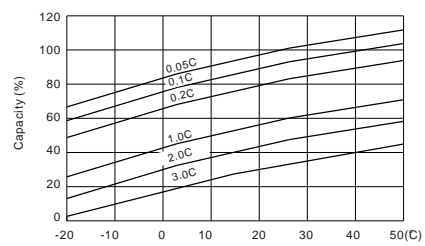
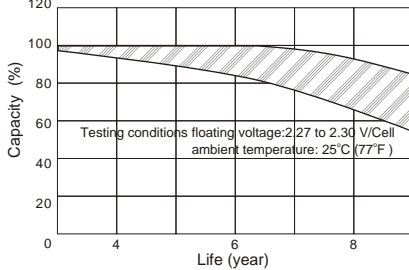
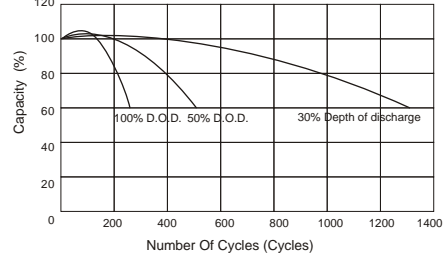
**Charge characteristic Curve for standby use**

**Discharge characteristic (25°C/77°F)**

**Relationship between charging voltage and temperature**

**Self-discharge characteristic**

**Temperature effects on float life**

**Temperature effects on capacity**

**Life characteristics of Standby use**

**Cycle service life in relation to depth of discharge**

**Constant Current Discharge Characteristics: A (25°C)**

F.V/Time	5MIN	10MIN	15MIN	30MIN	1HR	2HR	3HR	4HR	5HR	8HR	10HR	20HR
9.60V	110.6	81.41	63.46	38.67	21.45	12.83	8.858	7.338	6.178	4.220	3.500	1.868
10.0V	107.4	77.46	62.16	38.01	21.35	12.73	8.824	7.304	6.141	4.185	3.466	1.834
10.2V	104.2	74.73	61.18	37.30	21.15	12.63	8.756	7.270	6.105	4.151	3.433	1.800
10.5V	93.56	68.95	58.26	37.02	20.96	12.54	8.722	7.202	6.032	4.117	3.399	1.766
10.8V	84.45	62.88	53.70	36.39	20.46	12.31	8.485	7.032	5.923	4.048	3.365	1.732
11.1V	72.10	56.20	48.17	34.07	19.44	11.77	8.111	6.692	5.669	3.877	3.264	1.630

**Constant Power Discharge Characteristics: W(25°C)**

F.V/Time	5MIN	10MIN	15MIN	30MIN	1HR	2HR	3HR	4HR	5HR	8HR	10HR	20HR
9.60V	1167	867.0	691.8	434.0	247.9	151.2	105.41	87.46	73.70	50.38	41.82	22.39
10.0V	1144	840.4	680.7	428.7	247.3	150.4	105.45	87.35	73.51	50.14	41.56	22.00
10.2V	1130	818.2	673.1	425.6	245.4	149.5	104.99	87.16	73.26	49.81	41.19	21.60
10.5V	1029	761.9	642.0	422.7	243.2	148.4	104.58	86.35	72.39	49.40	40.79	21.19
10.8V	937.4	702.4	593.4	415.9	238.7	146.5	101.73	84.38	71.08	48.58	40.38	20.78
11.1V	823.3	635.0	534.2	391.7	228.5	141.1	97.34	80.31	68.03	46.52	39.17	19.56

(Note) The above characteristics data are average values.